



FICHA TÉCNICA DE PRODUCTO ADLER
ADLER PRODUCT SPECIFICATION SHEET

| | |
|------------------------------|-----------------------------|
| CATEGORÍA DE PRODUCTO | PRODUCT CATEGORY |
| CAJA DE PASO | JUNCTION BOX |
| NUMERO DE PARTE | PART NUMBER |
| CP - 15X20 (15 cm X 19 cm) | CP - 15X20 (5.9" X 7.5") |
| CP - 15X20 G (15 cm X 19 cm) | CP - 15X20 G (5.9" X 7.5") |
| PESO (APROX) | WEIGHT (APPROX) |
| 380 g | 13,4 oz |

| DATOS TÉCNICOS | | TECHNICAL DATA | |
|-----------------------------------|---|-------------------------------------|-----------------------------------|
| MATERIAL DE FABRICACIÓN | PVC RIGIDO | MANUFACTURING MATERIAL | RIGID PVC |
| COLOR | BLANCO / GRIS | COLOR | WHITE / GRAY |
| GRADO DE PROTECCIÓN IP | IP 65 | IP PROTECTION DEGREE | IP 65 |
| GRADO DE PROTECCIÓN IK | IK 05 | IK PROTECTION DEGREE | IK 05 |
| ENVOLTURA DE SELLADO | PERFIL REDONDO EN PVC (Ø2mm) | SEALING GASKET | PVC ROUND PROFILE (Ø2mm- 0.08 in) |
| VOLUMEN INTERNO (APROX) | 1600 cm ³ | INNER VOLUME (APPROX) | 1.6 L |
| AREA EFECTIVA BASE (APROX) | 250 cm ² | BASE EFFECTIVE AREA (APPROX) | 38.75 In ² |
| TIPO DE CIERRE | TORNILLOS (#6 X 1/2" - 3/4") 4 UNIDADES | FASTENER TYPE | SCREW (#6 X 1/2" - 3/4") 4 UNITS |
| PRECINTO DE SEGURIDAD | AGUJERO Ø 2mm | SECURITY SEAL | HOLE Ø 2mm - 0.08 in |

DIMENSIONES GENERALES / GENERAL DIMENSIONS

| BASE / BASE | DIMENSIONES / DIMENSIONS | | | | | | | | | | | |
|--------------------|---------------------------------|---------------|-------------------|---------------|------------------|---------------|------------------|---------------|-------------------|--------------|-------------------|---------------|
| | LARGO (L) | 190 mm | LENGHT (L) | 7.5 In | ANCHO (W) | 150 mm | WIDTH (W) | 5.9 In | ALTURA (H) | 71 mm | HEIGHT (H) | 2.8 In |

| TAPA / COVER | DIMENSIONES / DIMENSIONS | | | | | | | | | | | |
|---------------------|---------------------------------|---------------|-------------------|---------------|------------------|---------------|------------------|---------------|-------------------|--------------|-------------------|----------------|
| | LARGO (L) | 190 mm | LENGHT (L) | 7.5 In | ANCHO (W) | 150 mm | WIDTH (W) | 5.9 In | ALTURA (H) | 20 mm | HEIGHT (H) | 0.75 In |



INSTRUCCIONES DE MONTAJE PARA CAJAS DE PASO ADLER

ASSEMBLY INSTRUCTIONS FOR ADLER JUNCTION BOX

0 PARTES DE LA CAJA BOX PARTS

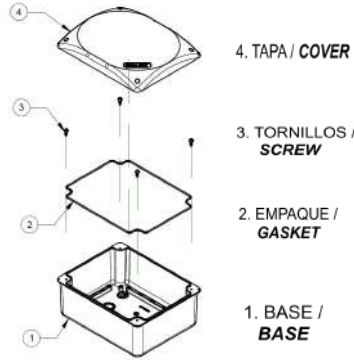

1 MARCAR POSICIÓN DE CAJA MARK POSITION OF BOX

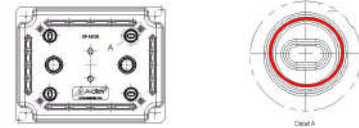
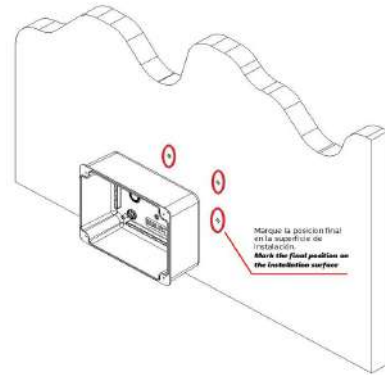

Retire las guías pretrazadas de la base de la caja, luego marque en la superficie de instalación la ubicación final de la caja.
Remove the engraved guides of the box base, then mark on installation surface the final location of the box.

2 FIJAR COMPONENTES ELECTRICOS FIX ELECTRICAL COMPONENTS

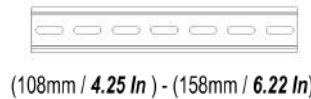
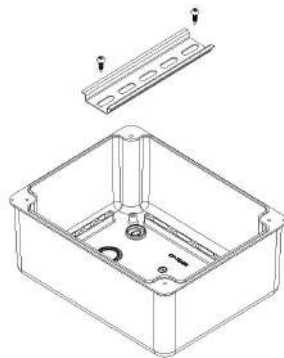

Realice agujeros en los laterales de la caja para instalar prensaestopos o bien monte el riel DIN sobre la caja para fijar los elementos eléctricos. Puede cortar el riel DIN a una distancia entre centro de 108mm para su lado más corto y de 158mm en su lado más largo, también puede instalar el riel DIN diagonalmente si así lo prefiere.
Make holes on box sides for installing cable glands. Also you can fix DIN rail for installation of electrical components. Cut DIN rail to 4.25 in between centers for fixing on shorter side and 6.22 in for longest side. If you prefer, the rail DIN can be also be fixed diagonally on the box.

3 FIJAR LA CAJA A LA SUPERFICIE FIX BOX AT SURFACE

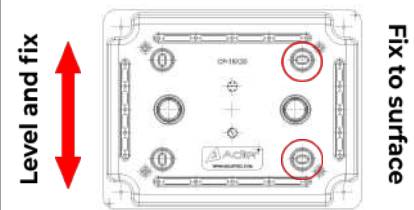

Ajuste la caja de un solo lado, utilice las ranuras de fijación para nivelar correctamente la caja y asegúrela a la superficie de instalación con 4 tornillos.
Fix the box just on one side, use fitting slots for correctly levelling, then fix on to the surface with 4 screws.

4 VERIFIQUE EL EMPAQUE CHECK SEALING GASKET

Verifique que la envoltura de sellado esté correctamente posicionada en la canal de la tapa.
Check that sealing gasket is correctly positioned on the box top cover channel.

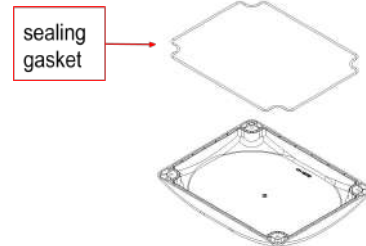

5 CIERRE DE TAPA CLOSE TOP COVER BOX

La caja incluye en el empaque 4 tornillos para fijar la tapa a la base, ajuste de forma cruzada.
Package of box includes 4 screws to fit the top cover to the base. Tighten the screws clockwise.

